



# Lineshaft and Submersible Turbine Pumps



BTURBINE

# TURBINE PUMP PRODUCTION





You not only get the latest in pump design and technology from Goulds Water Technology, you get more than 100 years of pump manufacturing know-how that includes most of the major innovations in pump engineering and materials. All our products reflect the engineering design advances for top efficiency and head generation.

Our engineers are specialists, using computer assisted design and extensive test and research facilities. They develop the specifications that guide our in-house pattern shop technicians in the development of precision turbine pattern equipment. The result is consistent casting accuracy, close tolerances and the quality needed to maintain water passage shape and pump efficiencies.



Goulds Water Technology further controls the quality of its products in its own foundries. Here the molding, core work and Vitra-Glass enameling are closely supervised for tight quality standards.



Our modern manufacturing facilities assure dimensionally consistent, high quality, fully machined parts, produced on a volume basis to bring down costs. Every impeller is precision balanced on a micro processor balance analyzer. Goulds Water Technology is one of the largest manufacturers in the turbine industry.

From design to pattern shop to foundry to manufacturing to warehousing – Goulds Water Technology is a completely integrated producer. Our network of turbine warehouses brings pumps and same day service to you. We offer full service on new units. Rebowling, rebuilding and repair on turbine pumps and submersible and centrifugal pumps.

We are committed to service. We offer ready availability of complete pumps, repair parts and service. We are continually improving and expanding our turbine products warehouse network with locations in key areas.



# LINESHAFT

## Water Lubrication

### 1 Adjusting Nut

Permits exact impeller adjustment for maximum performance.

### 2 Discharge Head

Heavy-duty head provides maximum accessibility to service packing box assembly. Two piece head shaft is standard.

### 3 Prelube Connection

### 4 Column Adapter

Accepts threaded or flanged column.

### 5 Adjusting Nipple

Threads directly into column adapter. Headshaft stickup set exactly by threading head on column as required.

### 6 Discharge Bowl Bearing

Bronze.

### 7 Discharge Bowl

Close grained cast iron.

### 8 Pump Shaft

Oversized high strength polished stainless steel.

### 9 Intermediate Bowls

Close grained cast iron. Waterways glass lined for maximum efficiency.

### 10 Impellers

Silicon bronze, designed for maximum efficiency. Precision balanced for smooth operation.

### 11 Intermediate Bowl Bearings

Bronze or rubber for long pump life under any well conditions.

### 12 Lock Collets

Steel construction secures impeller to pump shaft.

### 13 Sand Collar

Accurately located at suction bowl bearing to eliminate possible sand buildup.

### 14 Suction Bowl Bearing

Bronze. Grease packed for long trouble-free life.

### 15 Tail Pipe or Strainer – Optional

Optional tail pipe cut to desired length for best suction conditions. Strainer provides protection from large solids.

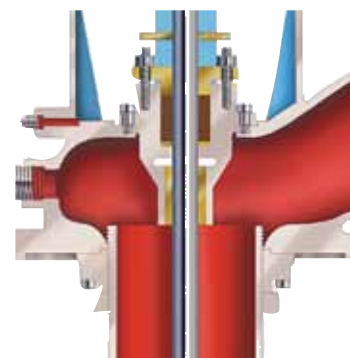
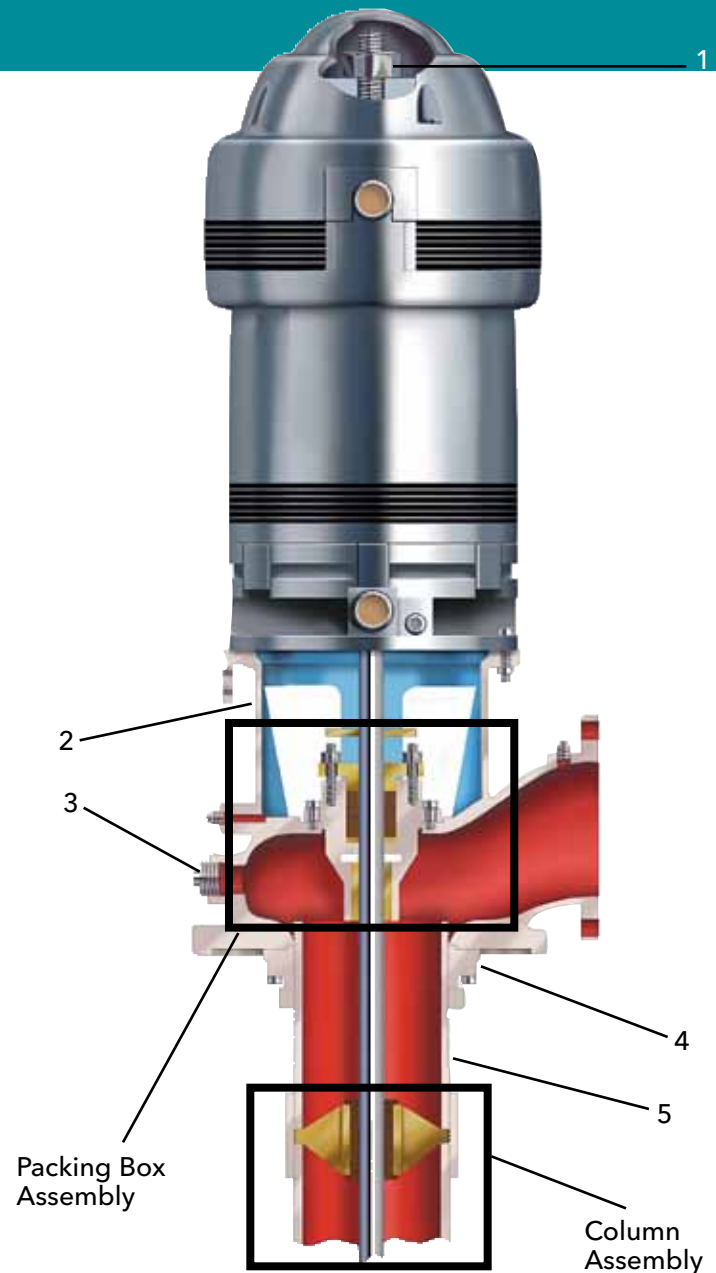

**Headshaft**  
Stainless Steel.

**Bronze Packing Gland Cast Iron Box**

**Throttle Bushing**  
Extra length bronze for better shaft support, longer packing life.



## Impellers

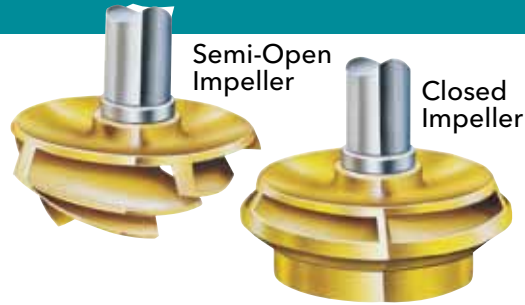

### Optional Long Lateral

Long lateral adjustment on some models for maximum setting capabilities.



### Glass Lined Bowls

Heavy-duty Class 30 cast iron intermediate bowls with standard feature of vitra-glass lined waterways for maximum efficiency and wear protection.



### Column Assembly

**Lineshaft**  
High strength steel with chrome spots. Ground and polished for exact bearing fit. Available in carbon steel or stainless steel.

**Bearing Retainer**  
Bronze.

**Lineshaft Bearings**  
Fluted rubber, designed to flush sand and grit rapidly.

**Column Pipe and Couplings**  
Parallel thread, accurately machined for easy installation, accurate alignment.

## Lineshaft Short Set Turbine

- Capacities to 9000 GPM (2043 m<sup>3</sup>/h)
- Heads to 1400 feet (427 m)

### Design Flexibility

Goolds Water Technology offers a wide variety of design options to suit most any short set turbine applications.

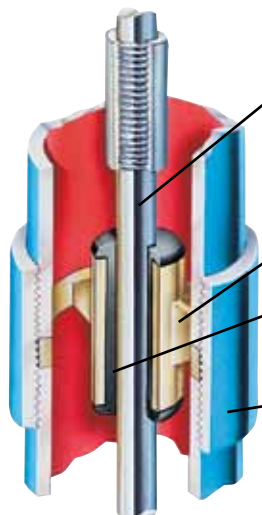
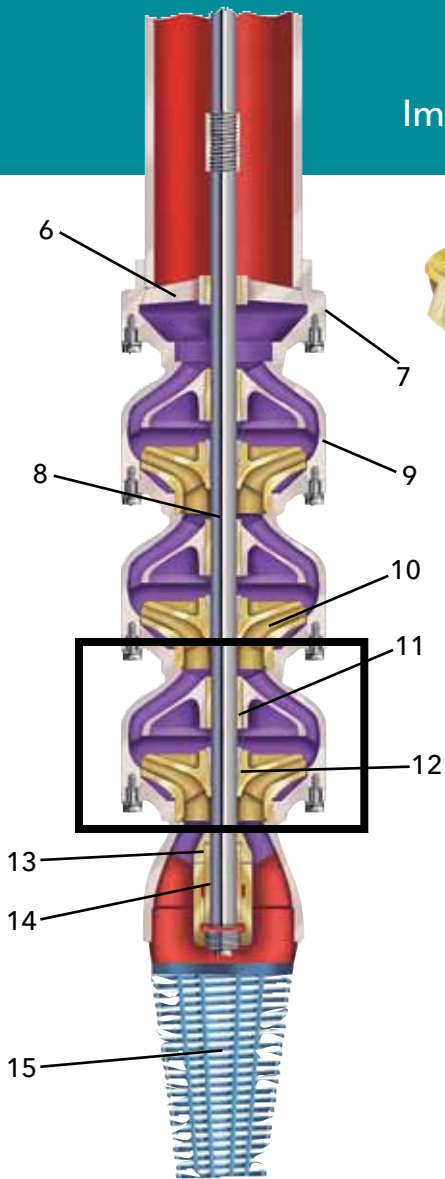
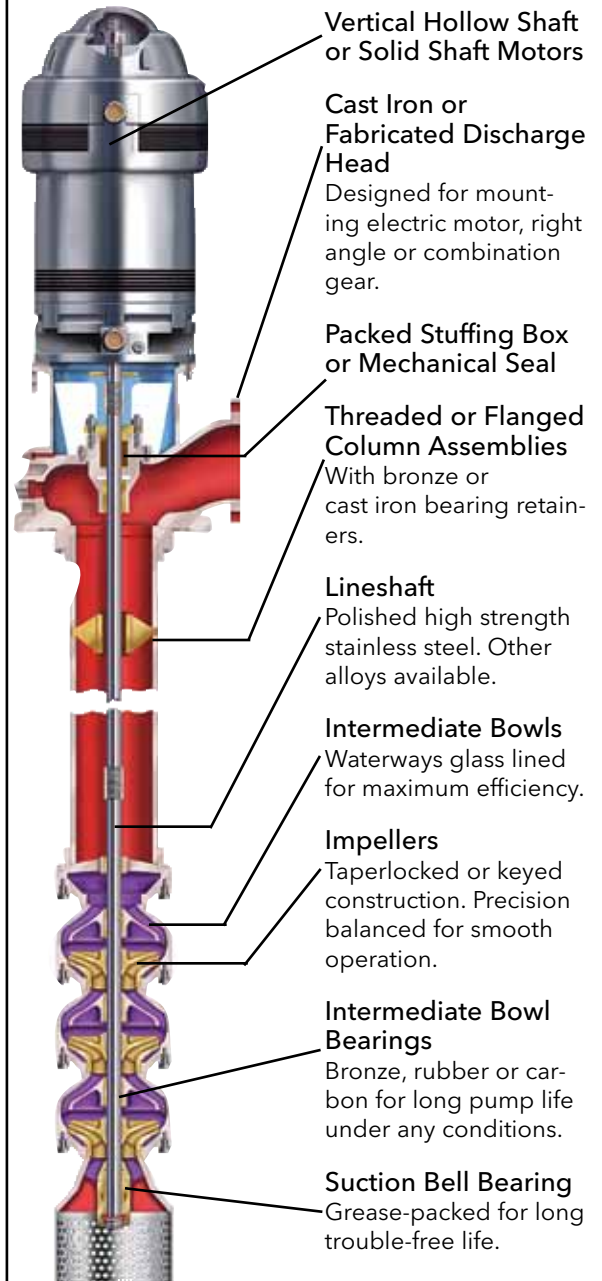

# LINESHAFT

## Oil Lubrication

- 1 Adjusting Nut**  
Permits exact impeller adjustment for maximum performance.
- 2 Large Capacity Manual or Solenoid Oiler**  
Assures constant oil supply.
- 3 Discharge Head**  
Heavy-duty head provides maximum accessibility to service tube tension assembly. Two piece headshaft is standard.
- 4 Lock Ring**  
Positively locks adjusting nipple to discharge head.
- 5 Adjusting Nipple**  
Threads directly into column adapter. Headshaft stickup set exactly by threading head on column as required.
- 6 Tube Adapter Bushing**  
Bronze.
- 7 Double Bowl Seal – Optional**  
Provides positive sealing of developed head.
- 8 Pump Shaft**  
Oversized high strength polished stainless steel.
- 9 Discharge Bowl**  
Close grained cast iron. Relief ports insure positive bearing lubrication.
- 10 Discharge Bowl Bearing**  
Bronze. Close tolerance fit for minimum leakage.
- 11 Impellers**  
Silicon bronze. Designed for maximum efficiency. Precision balanced for smooth operation.
- 12 Intermediate Bowls**  
Close grained cast iron. Waterways glass lined for maximum efficiency.
- 13 Intermediate Bowl Bearings**  
Bronze or rubber for long pump life under any well conditions.
- 14 Lock Collets**  
Steel construction secures impeller to pump shaft.
- 15 Sand Collar**  
Accurately located at suction bowl bearing to eliminate possible sand buildup.
- 16 Suction Bowl Bearing**  
Bronze. Grease packed for long trouble-free life.
- 17 Tail Pipe or Strainer – Optional**  
Tail pipe cut to desired length for best suction conditions. Strainer provides protection from large solids.

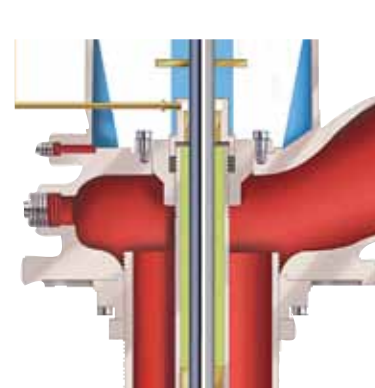
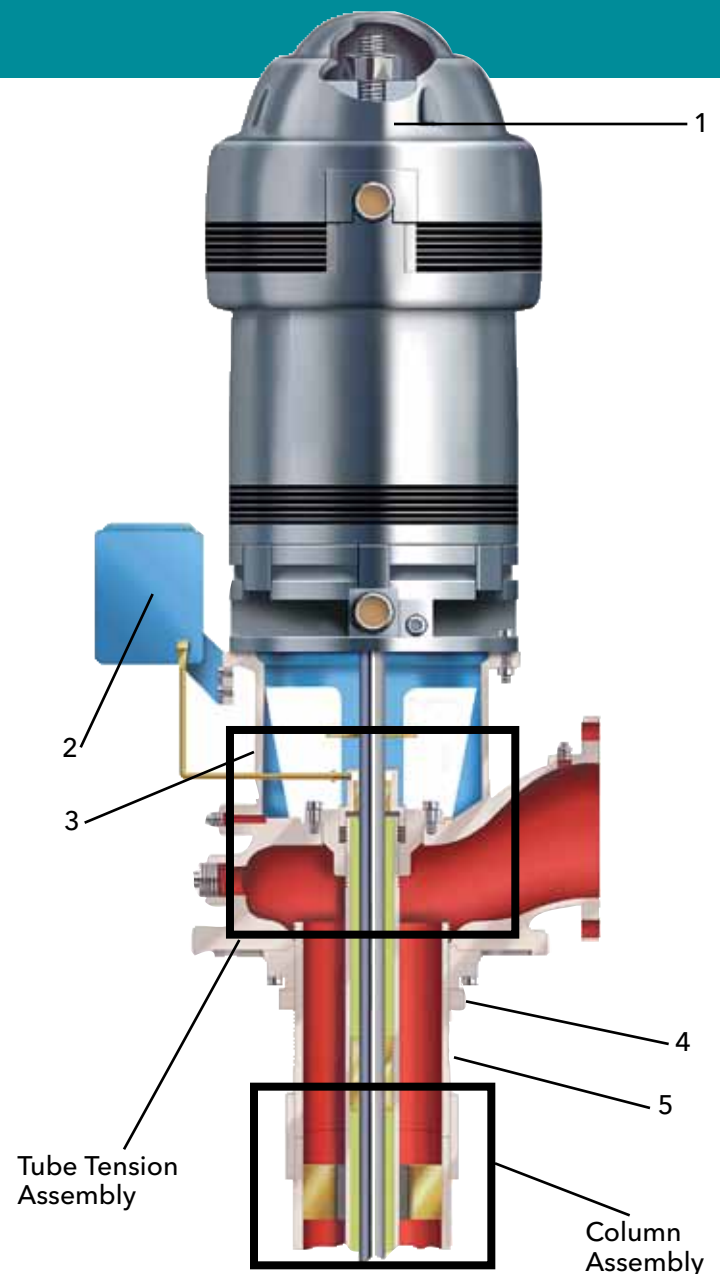

**Headshaft**  
Steel.

**Tube Tension Nut**  
Heavy-duty cast iron.

**Tension Nut Bushing**  
Bronze construction. Spiral groove insures positive lubrication to lineshaft bearings.

**Heavy-Duty Tension Plate**  
For positive alignment of lineshaft bearings.

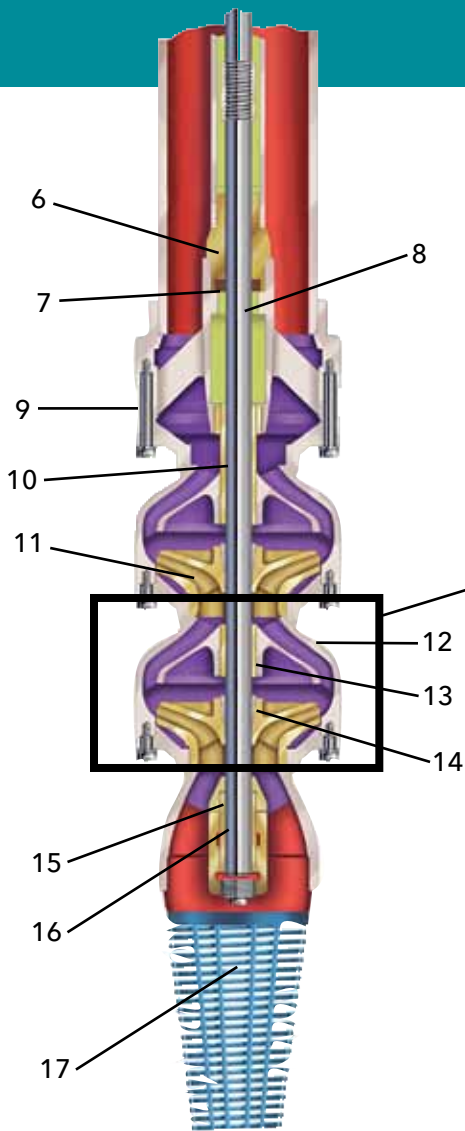

## Impellers

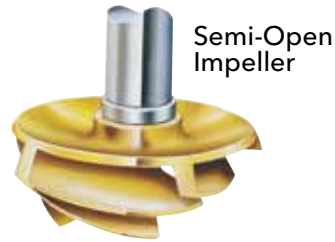

Semi-Open Impeller

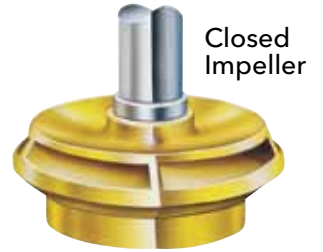

Closed Impeller



## Glass Lined Bowls

Heavy-duty Class 30 cast iron intermediate bowls with standard feature of lined waterways for maximum efficiency and wear protection.

## Optional Long Lateral

Long lateral adjustment for maximum setting capabilities. Available in some sizes.



## Column Assembly

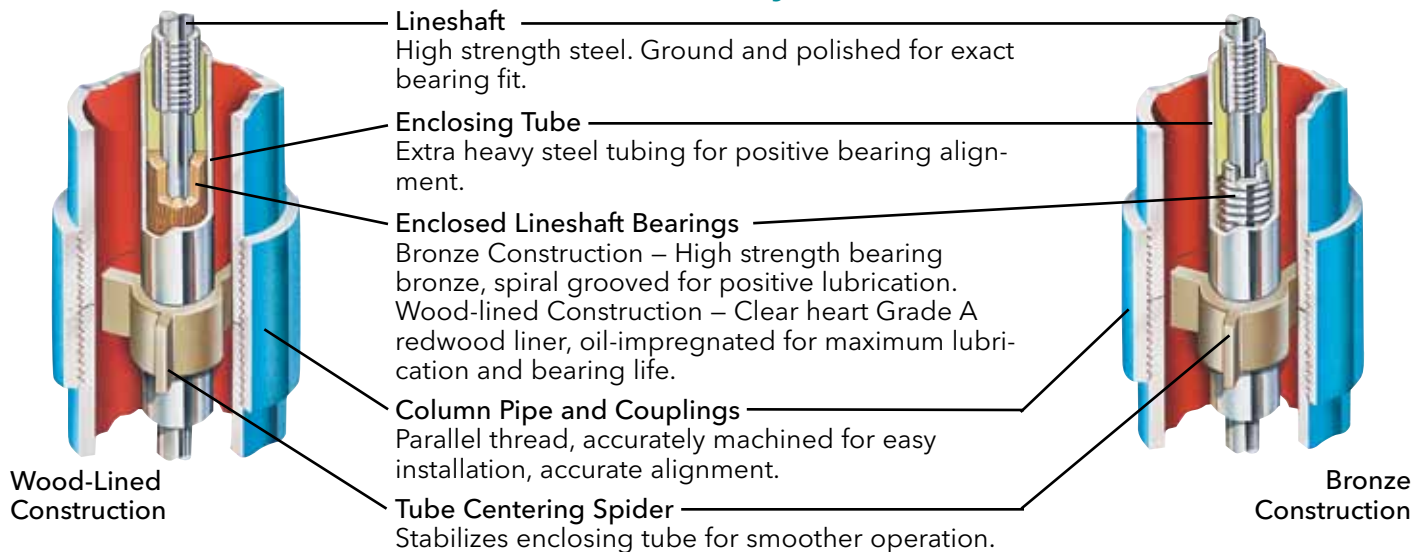

### Lineshaft

High strength steel. Ground and polished for exact bearing fit.

### Enclosing Tube

Extra heavy steel tubing for positive bearing alignment.

### Enclosed Lineshaft Bearings

Bronze Construction – High strength bearing bronze, spiral grooved for positive lubrication.  
Wood-lined Construction – Clear heart Grade A redwood liner, oil-impregnated for maximum lubrication and bearing life.

### Column Pipe and Couplings

Parallel thread, accurately machined for easy installation, accurate alignment.

### Tube Centering Spider

Stabilizes enclosing tube for smoother operation.

Wood-Lined Construction

Bronze Construction







Type "F"  
Head

Type "U"  
Discharge Located  
Underground

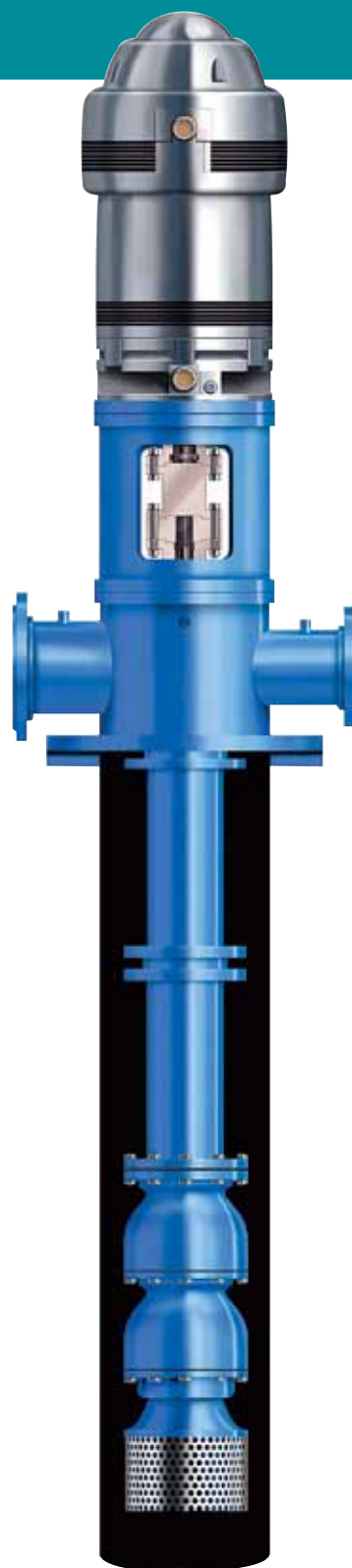

Type "T"  
Suction Inlet Located  
in the Head

Type "L"  
(Can) Suction Inlet  
Located in the Can



# SUBMERSIBLE

## Applications

Goolds Water Technology combines the hydraulic engineering of turbine pumps matched to the hi-tech design of electric submersible motors.

## Features

### 1 Discharge Pipe

Properly sized for optimum water velocities to insure peak hydraulic performance.

### 2 Discharge Bowl

Several discharge sizes available for NPT or flanged pipe.

### 3 Discharge Bearing

Extra long top protected bronze bearing insures positive shaft alignment and stabilization for extended life.

### 4 Intermediate Bowl

Close grained Class 30 cast iron. Water passage glassed for maximum efficiency and abrasion resistance.

### 5 Impellers

Designed for maximum efficiency with wide range hydraulic coverage. Precision balanced for smooth operation.

### 6 Upthrust Collar

Designed for extra margin of safety against possible momentary upthrust occurring at startup.

### 7 Intermediate Bowl Bearings

Reliable long life bronze or rubber bearing.

### 8 Lock Collets

Accurately machined to insure positive locking of impeller to pump shaft.

### 9 Pump Shaft

100,000 PSI high tensile stainless steel provides strength and excellent corrosion resistance. Ground and polished for smooth bearing surface.

### 10 Suction Inlet

Contoured for smooth flow entrance. Protected by an oversized stainless steel strainer to prevent entrance of damaging solids.

### 11 Suction Adapter

Ductile iron provides for increased strength and positive motor alignment. Open area permits easy access to pump/motor coupling.

### 12 Pump/Motor Coupling

Large stainless steel coupling accurately machined for perfect alignment, balance and power transmission. Submersible pumps and motors provide an extensive list of options versus other deep well pumping equipment systems. Advanced engineering designs and experience now assure units for long term pumping service. Water well applications provide the perfect opportunity to evaluate features and benefits of submersible equipment.

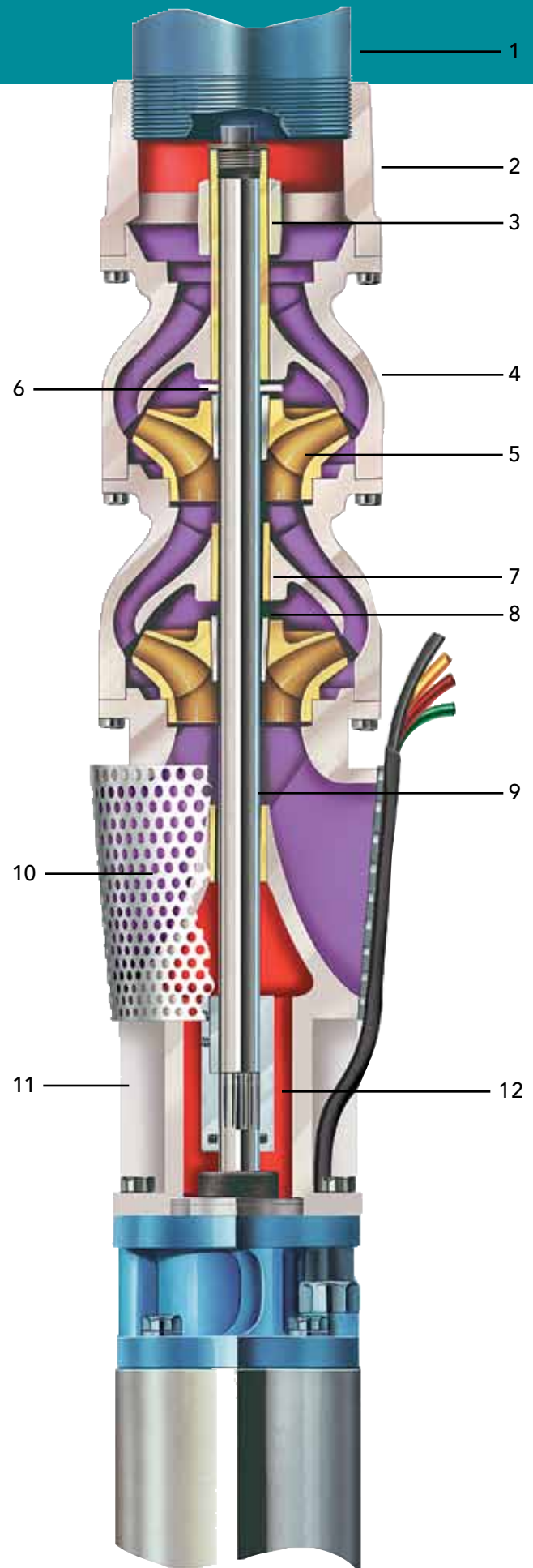

## Hermetically Sealed Type

A Hermetically Sealed Type motor utilizes windings of standard construction and insulation thickness. The windings are encased and Hermetically Sealed within the external shell casing on the outside and an internal tube or liner inside the bore. The Hermetically Sealed enclosure eliminates the possibility of water leakage into the winding the liquid medium circulates between the rotor and stator liner providing lubrication and cooling to the bearings.

## Wet Winding Type

A Wet Winding Type motor is one in which the motor windings are in direct contact with a liquid medium. The medium is clean, clear water. A pressure balancing system prevents exchange of the motor liquid medium and well water due to thermal expansion and contraction when the motor is operating. The liquid medium fills the inside of the motor and surrounds both the stator windings and the rotor. A completely water proof insulation is used on the magnet wire used for the stator windings. The liquid medium inside the motor air gap and coils acts as a heat transfer device by circulating through the windings and transferring heat to the external casing. Dissipation of this heat occurs as the well water flows at a required velocity over the external case. As is the case in all submersible type motors, the internal liquid medium is also used for bearing lubrication.



## Submersible Options

Goulds Water Technology can provide several options in pump and motor combinations to meet the exacting conditions of your applications:

- High temperature wells
- High horsepower, limited well diameters
- Motor sensing devices
- Water level indicators
- Special materials
- Special voltage motors

Consult Goulds Water Technology Turbine Customer Service Department for details.

## Submersible Accessories:

### Valves

- Check Valves
- Gate Valves
- Flow Control
- Ball Valves

### Electrical Panels

- Furnas Panels
- V.F.D. Drivers

### Pitless Adapters

### Wire

- 12 to 0000

### Heat Shrinks

### Splice Kits

### Tanks

### Well Heads

- Submersible Discharge Head

### Torque Arrestors

### Gauges

### Motor Shrouds



# SUBMERSIBLE

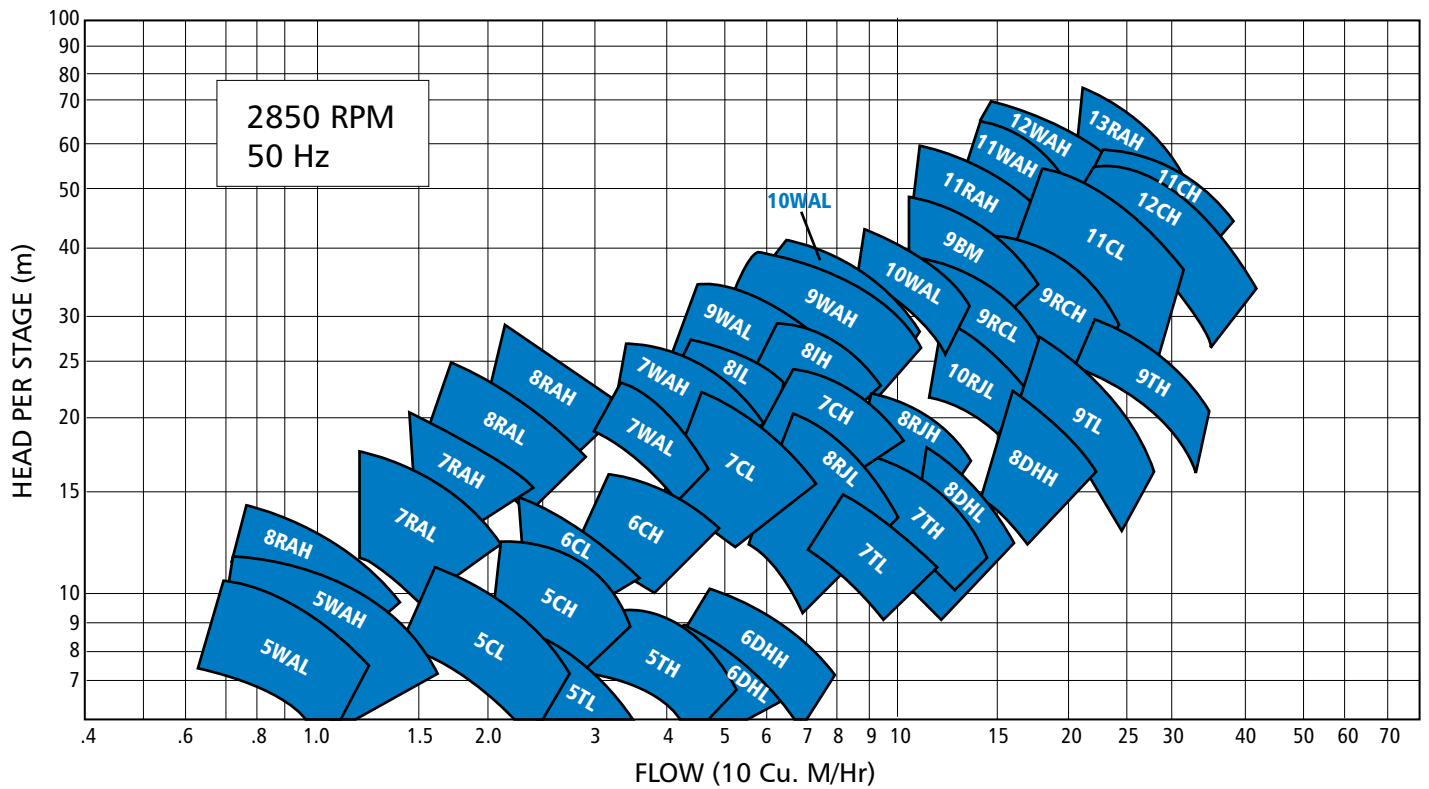
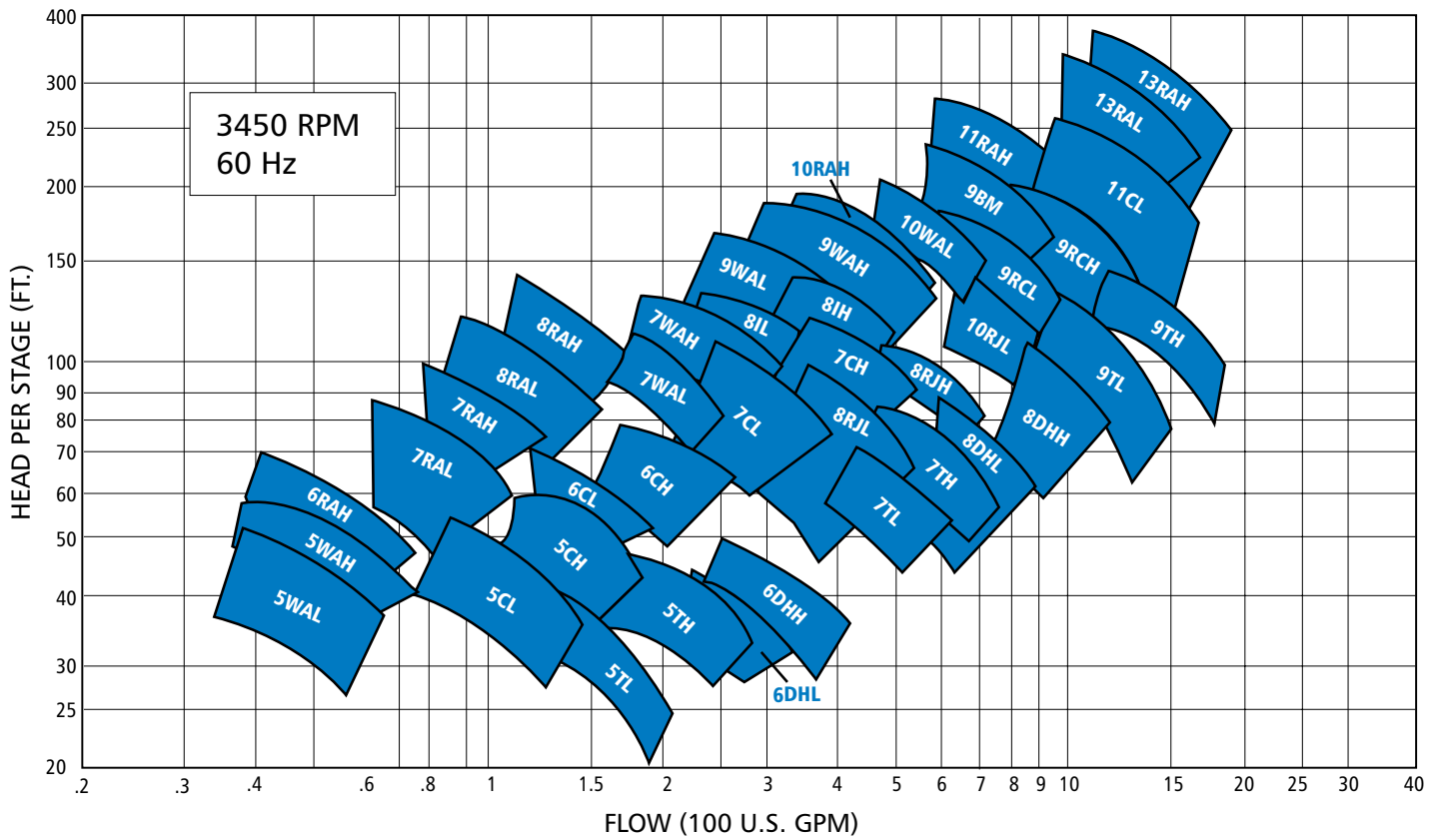

## Hydraulic Performance

The system requirements can be met with a choice of pump sizes and selections for the best hydraulic performance. The choice of pump and motor diameters, voltage and specs for varying well conditions provides additional opportunity to match the unit to all the requirements of the system.

The availability of accessory items, cable and controls enables you to rely on Goulds Water Technology for units that provide top service.

Submersibles for 1800 RPM through 20" are also available.

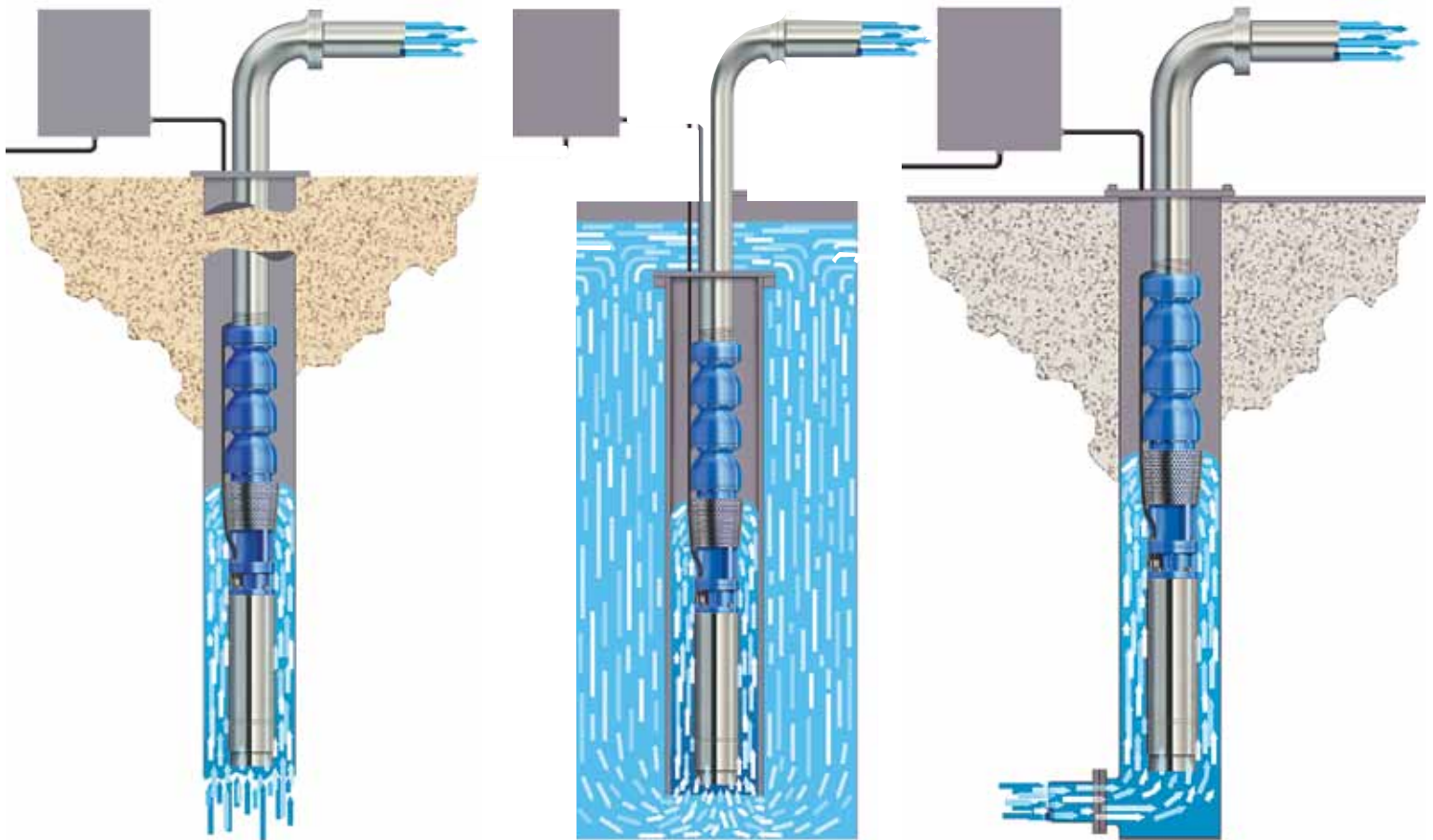
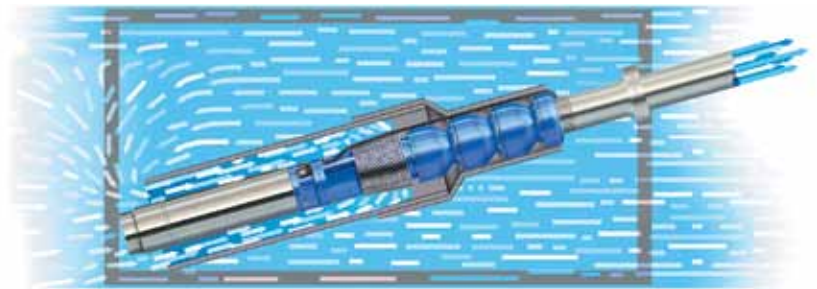
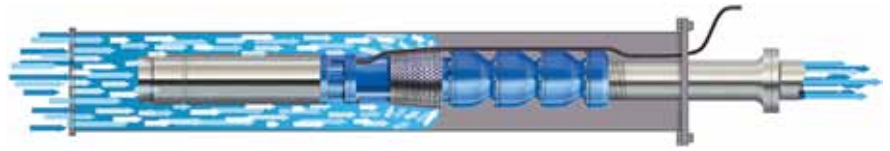

# LINESHAFT/SUBMERSIBLES

## Parts List Standard Materials of Construction

No.	Description	Material		
		GWT No.	Description	
1	Discharge Head	1003	C.I. ASTM A48,CL 30B	
2	Head Shaft	2227	Stainless – ASTM A582, Type 416	
		2205	Steel – AISI C1045	
3	Adjusting Nut	2130	Brass ASTM B16M C360	
4	Gib Key	2242	Mild Steel – ASTM A108, Gr. 1018	
5	Tension Nut	1187	Brass ASTM B584 C844	
6	Tension Plate	1003	Cast Iron – ASTM A48, CL 30B	
7	Oiler Body	1425	Aluminum – SAE 329 or Steel	
8	Stuffing Box	1003	Cast Iron – ASTM A48, CL 30B	
9	Stuffing Box Busing	1109	Bronze – ASTM B584 C89835 Federalloy III	
10	Stuffing Box Stud	2229	Stainless – ASTM A276 Type 316	
11	Stuffing Box Stud Nut	2229	Stainless – ASTM A276 Type 316	
12	Stuffing Box Gasket	5136	Garlock Brand Blue Guard	
13	Stuffing Box Split Gland	1193	Aluminum Bronze – ASTM B148HT	
14	Stuffing Box Slinger	5121	Rubber	
15	Packing	5026	Graphited Acrylic Yarn	
16	Column Nipple	6501	Pipe – ASTM A53	
17	Lock Ring	1018	Ductile – ASTM A536, Gr. 65-45-12	
18	Reducer-Bushing	1003	Cast Iron – ASTM A48, CL 30B	
19	Companion Flange	1003	Cast Iron – ASTM A48, CL 30B	
20	Companion Flange Gasket	5136	Garlock Brand Blue Guard	
21	Nameplate	3211	Stainless – ASTM A240, Type 316	
22	Sole Plate	3201	Steel Plate – ASTM A36	
23	Column Pipe	6501	Pipe – ASTM A53	
24	Column Coupling	6501	Pipe – ASTM A53	
25	Tube Nipple	6518	Pipe – Steel SCH80 ASTM A120 Gr. B	
26	Enclosing Tube	Bronze Construction	6518	Steel – SCH80, ASTM A120, Gr. B
		Wood-Lined Construction	6518	Steel – SCH80, ASTM A120, Gr. B
27	Oil Tube Coupling	Wood-Lined Only	6518	Steel – SCH80, ASTM A120, Gr. B
28	Lineshaft Bearing	Bronze Construction	1109	Bronze – ASTM B584 C903
		Wood-Lined Construction		Clear Heart Redwood – Grade A
29	Lineshaft	W/L – Sleeved	2205	Steel – AISI C1045 with Type 304SS Sleeve
		W/L – Stainless	2227	Stainless – ASTM A582, Type 416
		Oil Lube	2205	Steel – AISI C1045
30	Lineshaft Coupling	Water Lube	2242	Mild Steel – ASTM A108, Gr. 1018
		Stainless	2218	Stainless – ASTM A582, Type 416
31	Water Lube Retainer	Retainer	1102	Silicon Bronze – ASTM B584 C876
		Insert	5121	Rubber
32	Tube Centering Spider	5121	Rubber	
33	Discharge Bowl	1003	Cast Iron – ASTM A48, CL 30B	
34	Discharge Bushing	Water Lube	1109	Bronze – ASTM B584 C89835 Federalloy III
35	Throttle Bushing	Oil Lube	1109	Bronze – ASTM B584 C89835 Federalloy III
36	Intermediate Bowl		6911	Cast Iron – ASTM A48, CL 30B, Enameled
37	Top Inter Bowl		6911	Cast Iron – ASTM A48, CL 30B, Enameled
38	Inter Bowl Bushing	Bronze	1109	Bronze – ASTM B584 C89835 Federalloy III
		Rubber	5121	Rubber
39	Wear Rings – Optional	Inter Bowl	1117	AL Bronze ASTM B148 C954
		Impeller	1117	AL Bronze ASTM B148 C954
40	Impeller	1102	Silicon Bronze – ASTM B584 C876	
41	Taper Lock	2242	Mild Steel – ASTM A108, Gr. 1018	
42	Suction Bowl	1003	Cast Iron – ASTM A48, CL 30B	
43	Suction Bushing	1109	Bronze – ASTM B584 C89835 Federalloy III	
44	Sand Collar	1109	Bronze – ASTM B584 C89835 Federalloy III	
45	Suction Strainer	6952	Galvanized – ASTM A123	
46	Plug	1046	Steel – ASTM A197 Mall. Iron	
47	Screw Bearing	Bronze Construction	1109	Bronze – ASTM B584 C89835 Federalloy III
		Wood-Lined Construction	2242	Mild Steel – ASTM A108, Gr. 1018
48	Bowl Shaft	2227	Stainless – ASTM A582, Type 416	
49	Hex Bolt	2298	Steel – SAEJ 429, Gr. 8	
50	Lock Washer	2242	Steel – ASTM A108, Gr. 10180	
51	Suction Adapter	Submersible Only	1018	Ductile Iron – Astm A536, Gr. 65-45-12
52	Adapter Plate	Submersible Only (Optional)	1018	Ductile Iron – ASTM A536, Gr. 65-45-12
53	Motor Coupling	Submersible Only	2218	Stainless Steel – ASTM A582, Type 416
54	Motor Mounting Bolts	Submersible Only	2229/2228	Stainless – ASTM A276, Type 316/304SS
55	Suction Screen	Submersible Only	3215	AISI 304 Stainless
56	Cable Guard	Submersible Only	3215/6266	AISI 304 Stainless or Polyethylene (UHMW)
57	Discharge Bearing	Submersible Only	1109	Bronze – ASTM B584 C89835 Federalloy III
58	Discharge Bearing Plug	Submersible Only	1046	Steel – ASTM A197 Mall. Iron
59	Upthrust Washer	Submersible Only	6266	Polyethylene (UHMW)



# Services

- Municipal
- Wastewater Plants
- Commercial/Industrial
- Golf Courses/  
Turf Irrigation
  - Agricultural Irrigation
  - Dewatering
  - Mining
  - Cooling Tower
  - Water Parks
  - Snowmaking
  - Flood Control



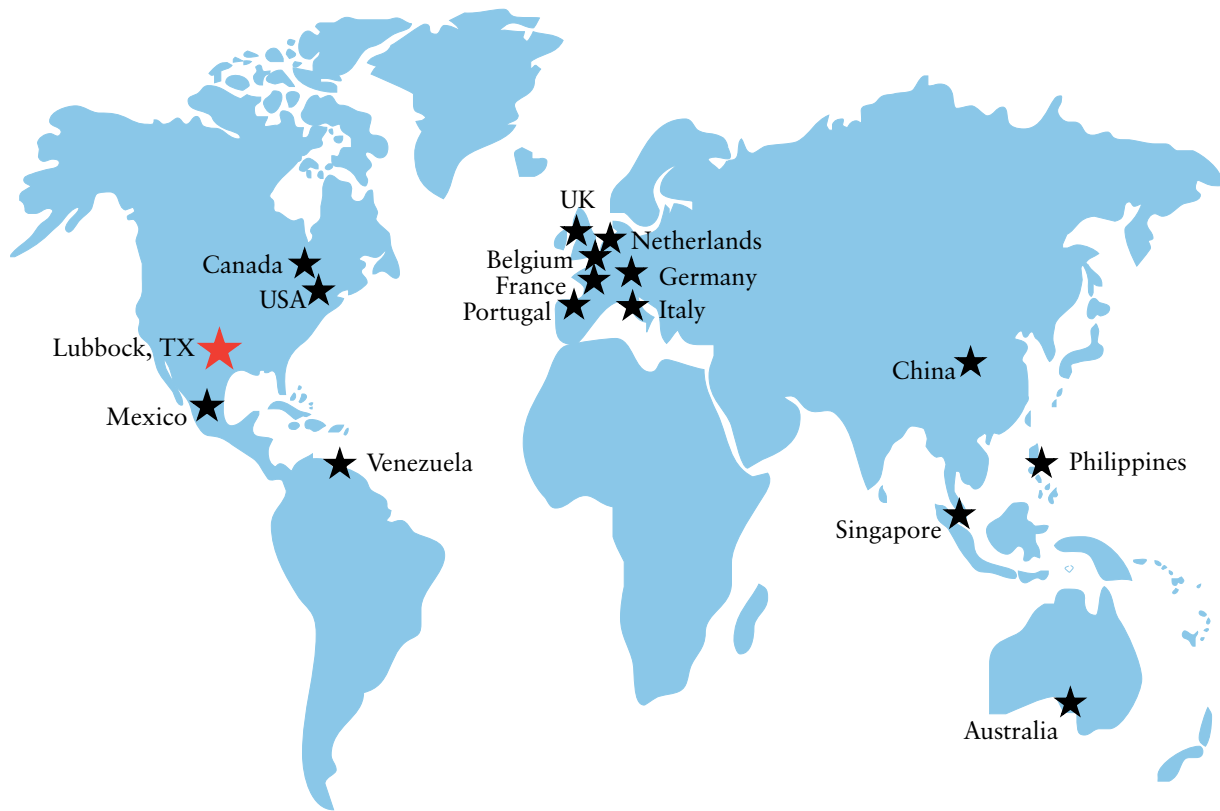

Goulds Water Technology, headquartered in Seneca Falls, New York, designs, manufactures and services pumps, motors and accessories for industrial, agricultural, municipal, commercial and residential markets. Our sales offices and manufacturing facilities are located worldwide.

Goulds Water Technology is a brand of Xylem, Inc., the world's largest and premier pump manufacturer, and offers the most complete range of pumps available.

<b>Turbine Distribution Centers:</b>	<b>Phone</b>	<b>Fax</b>
LUBBOCK P.O. Box 5487, Lubbock, TX 79408	1-806-763-7867	1-806-743-5730
MEMPHIS 1085 Stateline Road East, Suite 107, Southaven, MS 38671	1-662-393-5853	1-800-453-4745
ORLANDO 1150 Emma Oaks Trail, Suite 150, Lake Mary, FL 32746	1-407-829-7724	1-407-829-7725
FRESNO 3878 S. Willow Ave., #104, Fresno, CA 93725	1-559-265-4730	1-800-453-7523 1-559-265-4740
<b>Specifications &amp; Special Projects:</b>		
LUBBOCK CUSTOMER SERVICE CENTER	1-806-763-7867	1-806-743-5730



Xylem Inc.  
P.O. Box 5487  
Lubbock, TX 79408  
[www.xyleminc.com/brands/gouldswatertechnology](http://www.xyleminc.com/brands/gouldswatertechnology)

Goulds is a registered trademark of Goulds Pumps, Inc. and is used under license.  
© 2012 Xylem Inc. BTURBINE January 2012